



Your partner in surgery
DIAMOND® – Operating tables



A Sense of Company

With more than 90 years of experience, SCHMITZ is one of the leading international manufacturers of medical products.

A family-owned business with a living tradition. Our typical employee has been with the company for some 18 years, proof of how strongly they identify with our values and philosophy.

In 2012, the company's management passed to Friedrich and Matthias Schmitz, the fourth generation of the family.

We are proud to be located in Germany and are deeply rooted in our home region. We develop and manufacture here.

90% of our suppliers are from Germany, of which 60% are from the local region.

Made in Germany





A Sense of Care

We understand the services which are our lifeblood, and aim to achieve maximum customer satisfaction. From consulting through planning to installation.

Cost-effectiveness through longevity is what you can expect from us.

With a well thought-out service concept and comprehensive support, SCHMITZ works alongside you as partner from start to finish.

Technical Customer Service

T +49 (0)2377 84 549

service@schmitz-soehne.de

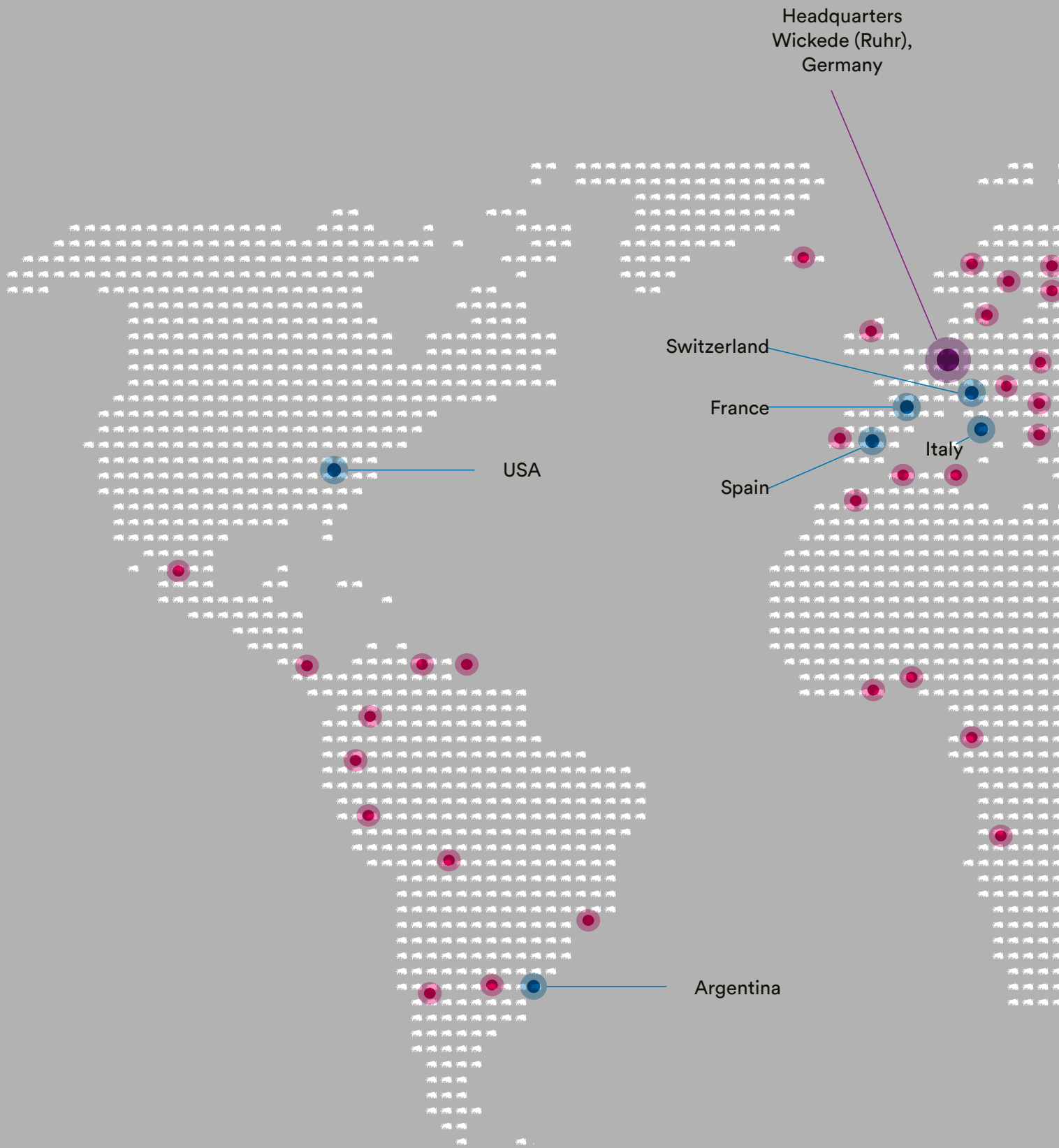

● Over 80 international trade partners

● Sales offices

SCHMITZ – represented worldwide





SCHMITZ

DIAMOND

DIAMOND® CE^{MD}**The operating table
for the most demanding requirements.****Ready for any requirement**

The DIAMOND® meets the demands and prerequisites of every surgical discipline in the OR theatre.

Perfectly thought-out operating concept

Guarantees safe and controlled handling.
Future-proof thanks to the latest technology.

Rethinking use and flexibility

The pre-release feature ensures a perfect workflow thanks to its intuitive operating comfort.

Offering loading capacity and flexibility in any position

Our innovative design meets exacting professional requirements.

Unrestricted functionality

The high conceptual standard enables optimal access and a high level of radiolucency.

Accessories for DIAMOND®

The range of options enables the operating table to be customised, thereby perfecting your workplace – oriented towards your structures.

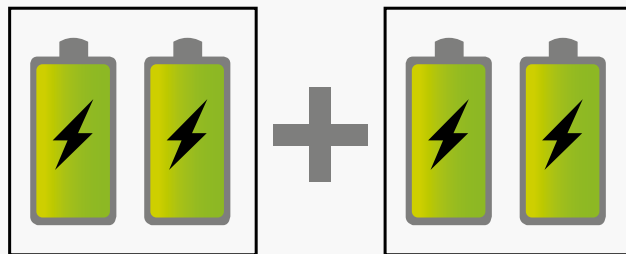

Dual Energy System



DIAMOND®

A multilevel security system ensures uninterrupted surgical proceedings

Dual-level security system for all table functions

Detachable manual emergency control unit for a continuously convenient table adjustment (for DIAMOND® 40 models: available as an option). Additional manual-hydraulic adjustment of all table functions with pre-selection dials and foot pump. First choose the desired function, then trigger the adjustment movement via the foot pedals. An extra locking mechanism in the hydraulic system provides added safety for all electro-hydraulic table movements. This means that the patient is safely positioned at all times.

Learn more about
DIAMOND®'s dual-level
security system!



Foot pedal on both sides for central locking
and activation of the optional directional castor.

Four battery modules in total,
grouped in two independent battery blocks, supply sufficient energy for well over two weeks with an average of 100 surgical interventions. By this means, two energy sources ensure operational readiness of the table and warrant a mains-independent electrohydraulic adjustment of all table functions.

The DIAMOND® operating table can be operated even when the mains cable is plugged in.

Integrated charging unit, additional selector button at the central delivery point for mains power and battery mode, potential equalization terminal and mains switch. All connections and buttons are splash-proof.

A soft-start function toggle

guarantees precise table movement, for example during spinal surgery or in neurosurgery, thanks to the soft start of the motors.

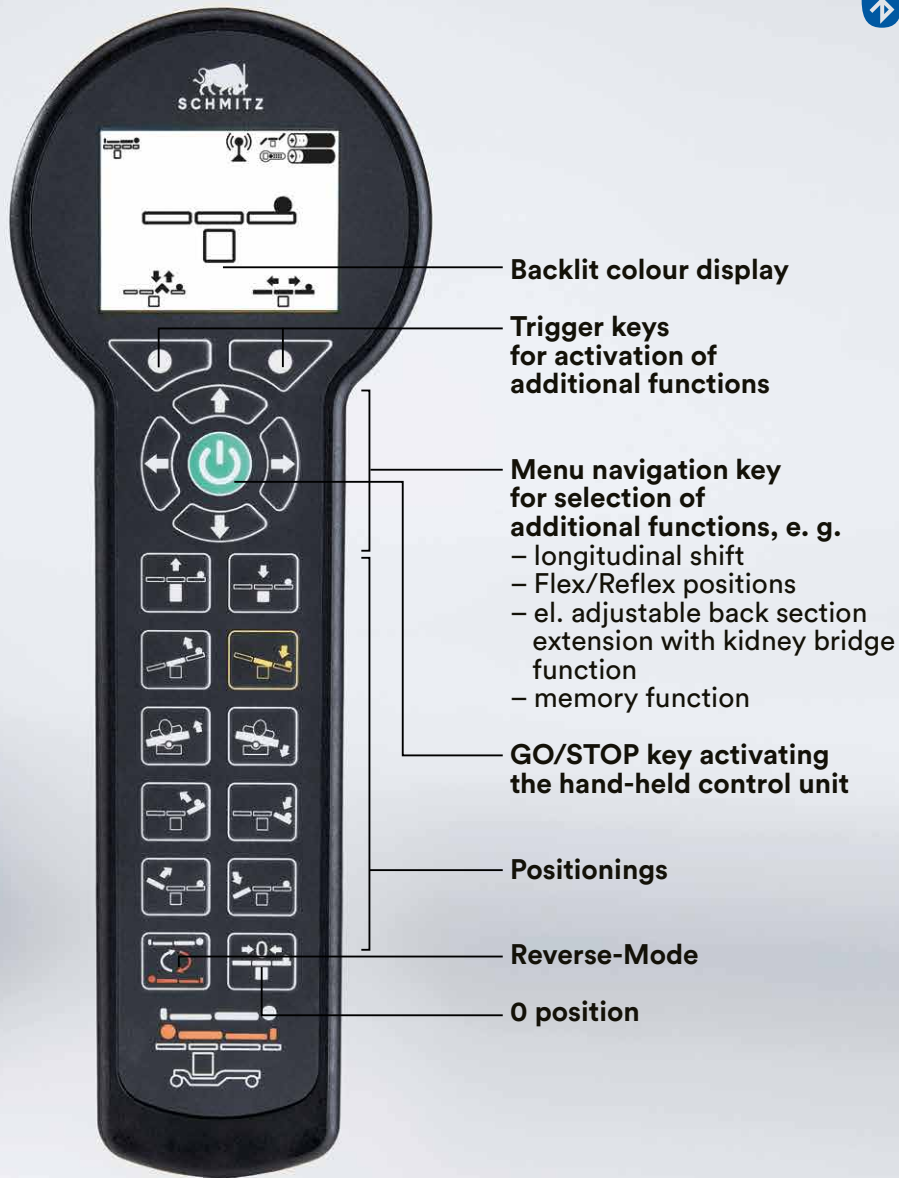

Integrated LEDs for illumination of the control panel



DIAMOND®

Security for operational readiness and patient

Hand control

Large, high-resolution colour display and backlit keypad. All status information for the table, e.g. currently selected position, reverse mode positioning and battery charge display at a glance. (optional wireless hand control with Bluetooth®)

Foot control

With backlit screen and large control panels for the desired table function. LEDs installed in the lifting bracket illuminate the foot control operating panel, even in the darkened operating theatre. (optional wireless foot control with Bluetooth®)

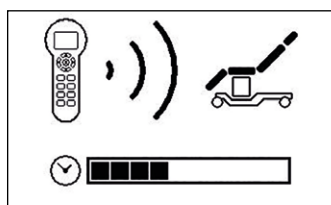

Examples of status information in the display

The Bluetooth® control unit connects to the DIAMOND® operating table.

Wireless operation via Bluetooth®

Bluetooth® technology allows a continuous operation of the OR table, regardless of sterile covers or the like that may come in between the control unit and the OR table. The Bluetooth® control unit communicates exclusively with its assigned operating table, there is no danger of unintentionally activating a different device. The bidirectional connection constantly monitors the current status of the operating table and displays it on the colour screen of the hand control.



Bluetooth® is not available in all markets, please get in touch with us!

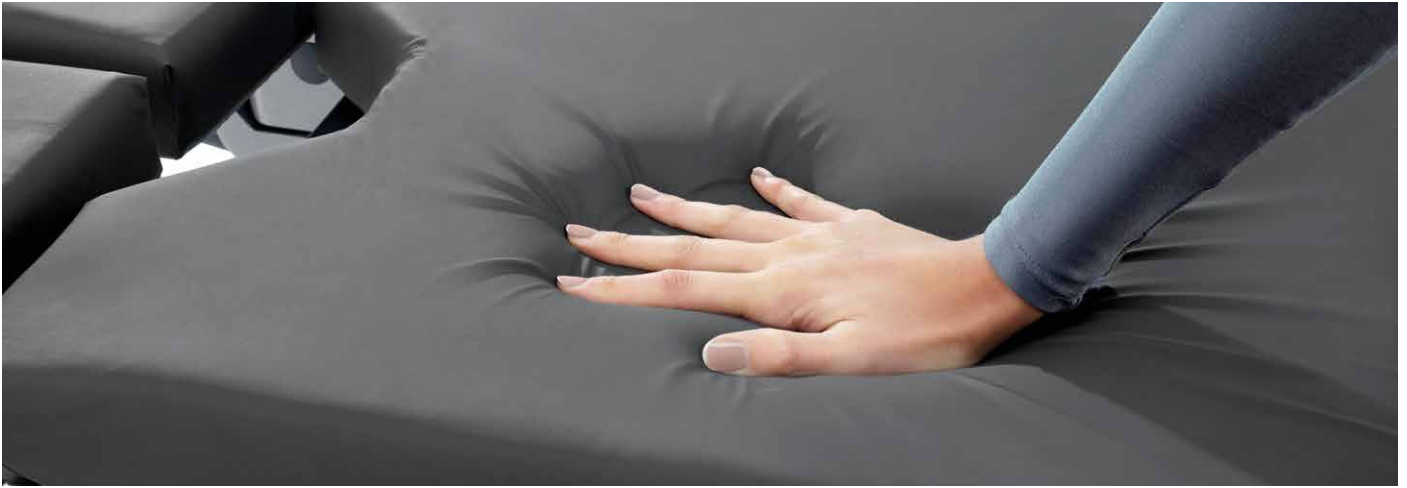

IEC / IECB / IECB SCHEME		Ref. Certif. No.
		DE1-63695
IEC SYSTEM FOR MUTUAL RECOGNITION OF TEST CERTIFICATES FOR ELECTRICAL EQUIPMENT (IECEE) CB SCHEME		
CB TEST CERTIFICATE		
Product	Operating table	
Name and address of the applicant	Schmitz u. Söhne GmbH & Co. KG Zurb Oatenfeld 29, 58739 Wickede (Ruhr) GERMANY	
Name and address of the manufacturer	Schmitz u. Söhne GmbH & Co. KG Zum Oatenfeld 29, 58739 Wickede (Ruhr) GERMANY	
Name and address of the factory	Schmitz & Soehne GmbH & Co. KG Werk Boenen, Rudolf-Diesel-Straße 5, 59199 Boenen, GERMANY	
Notes: Where more than one factory please report on page 2	<input type="checkbox"/> Additional information on page 2	
Rating and principal characteristics	110 - 220 V AC; I max. 4 A; 50/60 Hz 220 - 240 V AC; I max. 2 A; 50/60 Hz INT 1,5 min. ON / 8,5 min. OFF	
Trademark (if any)	SCHMITZ	
Customer's Testing Facility (CTF) Stage used	DIAMOND 40; DIAMOND 50; DIAMOND 80 maybe followed by suffix "K", "LK", "BK", "BLK"	
Model / Type Ref.		
Additional information (if necessary may also be reported on page 2)	<input type="checkbox"/> Additional information on page 2	
A sample of the product was tested and found to be in conformity with:	IEC 60601-1:2005, IEC 60601-1:2005/AMD1:2012, IEC 60601-1-6:2010, IEC 60601-1-6:2010/AMD1:2013, IEC 60601-2-46:2016	
As shown in the Test Report Ref. No. which forms part of this Certificate	264220-TL4-1, 264220-TL4-2, 264220-TL4-3	
This CB Test Certificate is issued by the National Certification Body		
VDE Prüf- und Zertifizierungsinstitut GmbH VDE Testing and Certification Institute Zertifizierungsstelle und internat. Angelegenheiten Certification Body and internat. Affairs		
Date: 2020-06-24	Signature: <i>G. Hone</i> G. Hone	

DIAMOND®

Security for operational readiness and patient

Memory foam pads

provide an efficient decubitus prophylaxis, reduce body heat loss and provide at the same time an enhanced comfort to the patient.

Integrated sensors

alert the user visually via the display, acoustically by means of a warning beep and tactilely via vibrating alert to an imminent collision and stop the table movements automatically (model-dependent equipment feature). Warnings can, however, be overridden at any time for maximum flexibility (see also pages 18 - 21).

An unintentional table movement is prevented

by the automatic switch-off function of the hand control unit after 60 seconds (adjustable). In addition, the adjustment mechanisms of the head and leg sections are secured against an unintentional triggering. For safety reasons, only one hand control can be used at any one time for table adjustments.

Adjustment of the individual table segments

is carried out step by step and therefore gently on the patient. There is no risk-incurring simultaneous adjustment of several elements.

Tested for safety following the CB scheme according to IEC 60601

SCHMITZ fulfils all standard requirements, not just for the CE marking, but also for IEC 60601, tested by an independent and approved German testing institute.

DIAMOND® CE^{MD}

Future-proof software and electronics

Thanks to our in-house-developed electronic parts and software, the DIAMOND® OR table is future-proofed for the requirements to come. Regular updates for new software functions are thus assured.



Charging cradle

Inductive charging of Bluetooth® hand controls in charging cradle. Choose from an upright version, a charging cradle for the side rail or practical wall mounting. The right storage solution for your Bluetooth® hand controls, no more random cabling. The operating table can still be adjusted during the charging process using the hand control located in the charging cradle.



Activation by Motion

Automatic activation of hand control upon lifting it. No more searching for the on/off button during operations in darkened theatres.



Memory positions

Up to eight individually selectable positions can be stored and quickly and easily accessed at the touch of a button. The stored position is depicted graphically on the display.

Custom 0 position

Saving a custom height setting using the 0 position button allows you to easily transfer the patient to a bed or transporter performance.



Backlit control unit

Backlit control panel for a safe and easy handling even in the darkened operating room.



Hand control vibration

The haptic feedback for detected dangers, e.g. to warn of a collision, allows medical personnel to concentrate on the patient.



Soft-start function

When it comes down to millimetres! DIAMOND® operating tables feature a soft-start function for fine-tuning. This allows a millimetre-precise adjustment thanks to the soft start-up of the motors.

SCHMITZ integration module

for an optional integration of the DIAMOND® operating table into the Storz OR1™ or a different central control system, secure bidirectional data transfer. Please let our experts advise you.



The DIAMOND® sensor system

❶ Brake sensors

For safety reasons the table can only be moved via the control elements when the castor brake is activated. The user is informed that the castor brake must be engaged visually on the display, tactilely by vibration and audibly by a warning signal. The castor brake is not dependent on the power supply to the table.

❷ Crash Detection System

Likewise, integrated sensors stop the operating table from moving in the back and leg joint areas before an anticipated collision occurs. To this end, the current position values of the longitudinal movement, lateral adjustment, Trendelenburg and reverse Trendelenburg and height are evaluated. Warnings can be overridden at any time for maximum flexibility. As with all other collision sensors, there is also a visual, tactile or audible warning.

❸ Telescopic lifting column sensor system

This recognises when objects have become wedged between the column cladding and foot section and stops the height adjustment immediately, thus preventing damage to the table. The height adjustment can be used to raise the table and safely remove the object.

❹ Battery status of operating table

You can check the current status of the table's batteries via the designated technician menu on the hand control. Voltage and temperature provide technical staff with valuable information about possible damage or malfunctions.

❺ Battery charge indicator

The control units show the current battery status at all times. At 20% capacity the low battery indicator is displayed on the screen.



Important!

The following pages provide information about selected status messages for the operating table.

Please also note the information in the DIAMOND® instructions for use!

DIAMOND® CE^{MD}

Examples of status messages

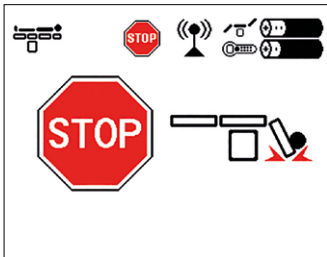

Warning of an impending collision at the head end of the table.

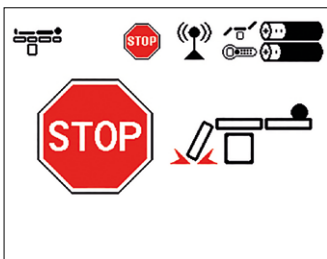

Warning of an impending collision at the foot end of the table.

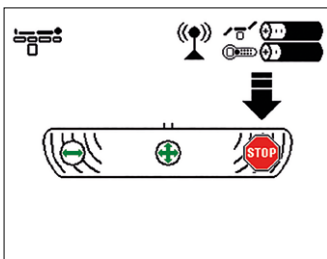

Notification to activate the castor brake in order to move the table.

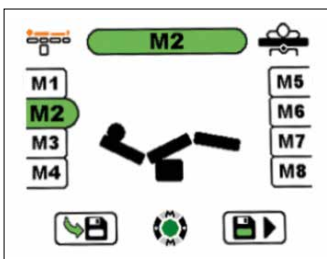

Visual display of saved position in the memory menu.

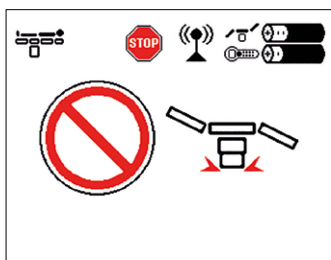

Notification that an object has been detected between the column cladding and the foot section.

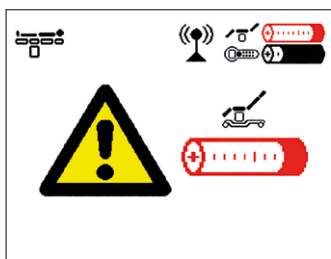

Low battery notification.

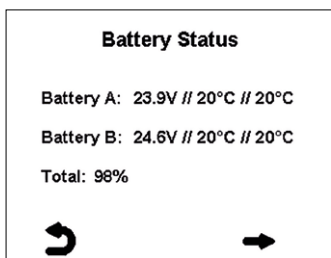

Information about the current status of the battery installed in the table.



DIAMOND® CE^{MD}

Hygiene

Pads are secured with adhesive gel strips

to ensure they stay in place. However, they can be adjusted so that pads can be positioned to suit the patient.

Easy cleaning

of the adhesive gel strips using a damp cloth. The adhesive gel strips are disinfection-proof creating optimised hygienic conditions inside the OR theatre.

Protection in fluid-intensive surgeries

The optional splash guard for the central delivery point at the foot of the DIAMOND® operating table serves as a protection in fluid-intensive surgeries, e.g. in urology or obstetrics. The cleaning effort for the DIAMOND® operating table is reduced significantly.

Cleaning shuttle

Even the underside of the DIAMOND® operating table, so often a critical issue from the point of view of hygiene, can be conveniently cleaned by means of the cleaning shuttle. The DIAMOND® Operating table is moved into the device with the table top in its highest position, the frame of the cleaning shuttle is positioned under the seat section of the table. Lowering the table top then lifts the table base off the floor and gives access to its underside for cleaning.



DIAMOND® CE^{MD}

Mobility and ergonomics

High degree of directional stability and manoeuvrability

thanks to an optional 5th castor and large double castors with a diameter of 125 mm. Moving patients around tight corners or down long corridors can be done with minimum effort.

DIAMOND® can also be moved easily inside the operating theatre according to the requirements of the surgical intervention.

Without the use of motor-driven braking systems, the self-levelling base can automatically compensate for ground unevenness of up to 10 mm.

Triple-function pedals on both sides of the table base for:

- Straight run with activation of the 5th castor for moving down long corridors or turning on the spot. The DIAMOND® table retains its directional stability, even with a patient lying on top.
- Free manoeuvring with disabled 5th castor, e.g. inside the operating theatre in order to meet a change in positioning requirement during a surgical intervention.
- Brake function with locking of all castors providing high stability (5th castor available as an optional accessory)

Integrated recessed grips

The integrated recessed grips make the elements easy to transport and attach or remove.

Head and leg plates removable at the push of a button

The quick, safe replacement means that patients can be positioned in all table configurations. Table elements and all plug-in accessories can be easily attached to a secured mount thanks to a button and pre-release mechanism, making the process effortless for staff. The integrated recessed grips make the elements easy to transport and attach or remove.

Learn more about the pre-release mechanism of the DIAMOND®!



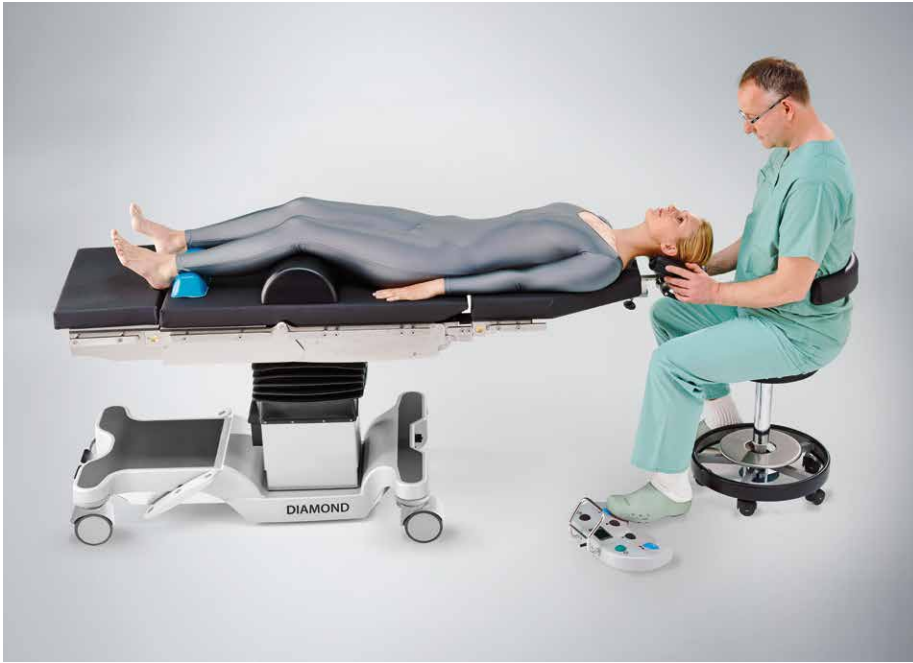

DIAMOND® CE^{MD}**Foot space and stability****Reverse Mode function**

Thanks to the Reverse Mode function, the DIAMOND® offers excellent leg space to the surgical team and at the same time an improved intraoperative fluoroscopy.

Reverse mode allows the operating table to be adjusted to all requirements during surgery.

Foot space

The table base is shaped to offer optimal foot space to the surgeon.

A high stability

against traction and compression forces allows challenging positions using the extension device.



MIS



High weight capacity
up to 454 kg

DIAMOND® CE^{MD}

Work safely, even with a heavier load

Reliable – even with heavy loads

With a static working load of up to 454 kg, the DIAMOND® operating table is perfectly equipped for every type of procedure, thanks to carefully selected and robust components, as well as a proven hydraulic system.

The head and leg plate and back section extension allow a safe working load of up to 360 kg in both normal orientation and in reverse mode with dynamic movement.

Safe positioning of the patient

Even severely obese patients can be safely positioned with the DIAMOND® operating table. Both the operating table itself and its accessories are designed to position the patient effectively and comfortably and support surgeons with their work.

The right accessories for every position

Whether leg restraint straps, foot plates or table extensions – the range of accessories for DIAMOND® operating tables is designed to suit all commonly used positions. The universal operating table for every type of surgery.

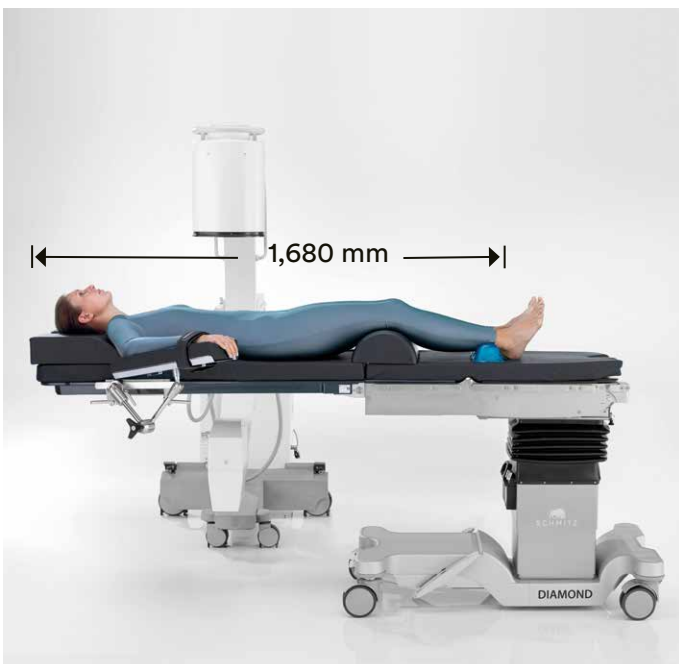

DIAMOND® CE^{MD}

Longitudinal adjustment and X-raying

Unlimited X-rays

The DIAMOND® tabletop can be moved a total of 300 mm lengthways (DIAMOND® 40 LK and DIAMOND® 60 BLK models). This results in a surface of 2,100 mm, equivalent to approx. 98 % of the lying surface, which allows for unrestricted x-rays of the patient while optimising leg and foot room. In addition to the slim column design with only approx. 300 mm maximum width, this simplifies access for the C-arm.

Optimised access
for the C-arm,
find out for yourself!



Optimised access for C-arm use

Thanks to the option to move the tabletop lengthways, the DIAMOND® operating table is optimised for C-arm x-rays.

Carbon accessories

A carbon plate can be attached to further improve the X-ray procedure and access to the operating area. This increases the possible x-ray area to up to 1,680 mm at the head end alone.

Optional double panels

in the DIAMOND® OR table top allow the use of all common X-ray cassettes.





Thoracic positioning

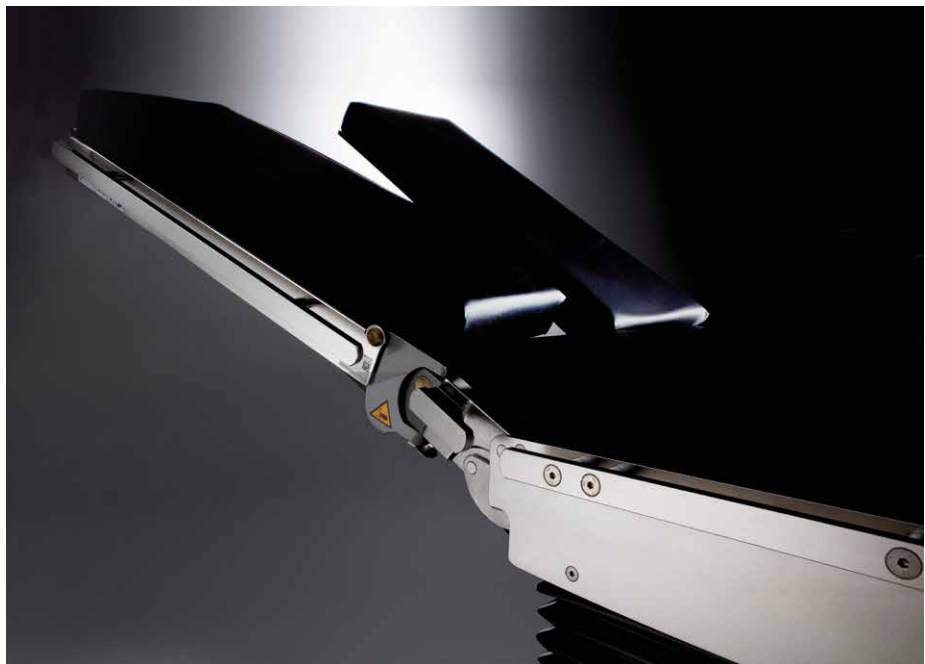

DIAMOND® CE^{MD}**Performance features****Electrically adjustable back section extension**

with kidney bridge function underlines the flexibility of the DIAMOND® as an operating table for all disciplines

This means that thorax or gallbladder operations can be performed with patients in the lateral or supine position. It can be attached when necessary and is not permanently fixed to the table.

Electrohydraulic leg section and leg support adjustment function, also serving as back section adjustment function in Reverse Mode

allows a precise patient position and intraoperative corrections of position. (model-dependent equipment feature)

Generous height adjustment range

Optimal access to the surgical field in both standing and sitting surgery. Fatigue-free and ergonomic surgical work.

Multilevel telescopic lifting column – Made by SCHMITZ

with a lift of 500 mm and an initial height of up to 620 mm (depending on the model). The low-maintenance design of the telescopic lifting column guarantees a long service life.



DIAMOND® CE^{MD} Manufacturing standard

Quality made in Germany

‘Made in Germany’ is far more than a motto.

With production in Bönen and 90% of our suppliers based in Germany – 60% of which are even from our local region – we are a truly German enterprise embodying high manufacturing standards. By avoiding unnecessary transport from overseas, we are also trying to do our bit to protect the environment!

The DIAMOND® operating table leads the pack in terms of its capabilities and specifications in every discipline – reliability at the very highest level.

Premium materials

Stainless steel of the highest quality, stainless steel inlays made of premium V4A stainless steel – corrosion-resistant with a smooth surface, lightweight and easy to clean.



reddot design award

Made in Germany



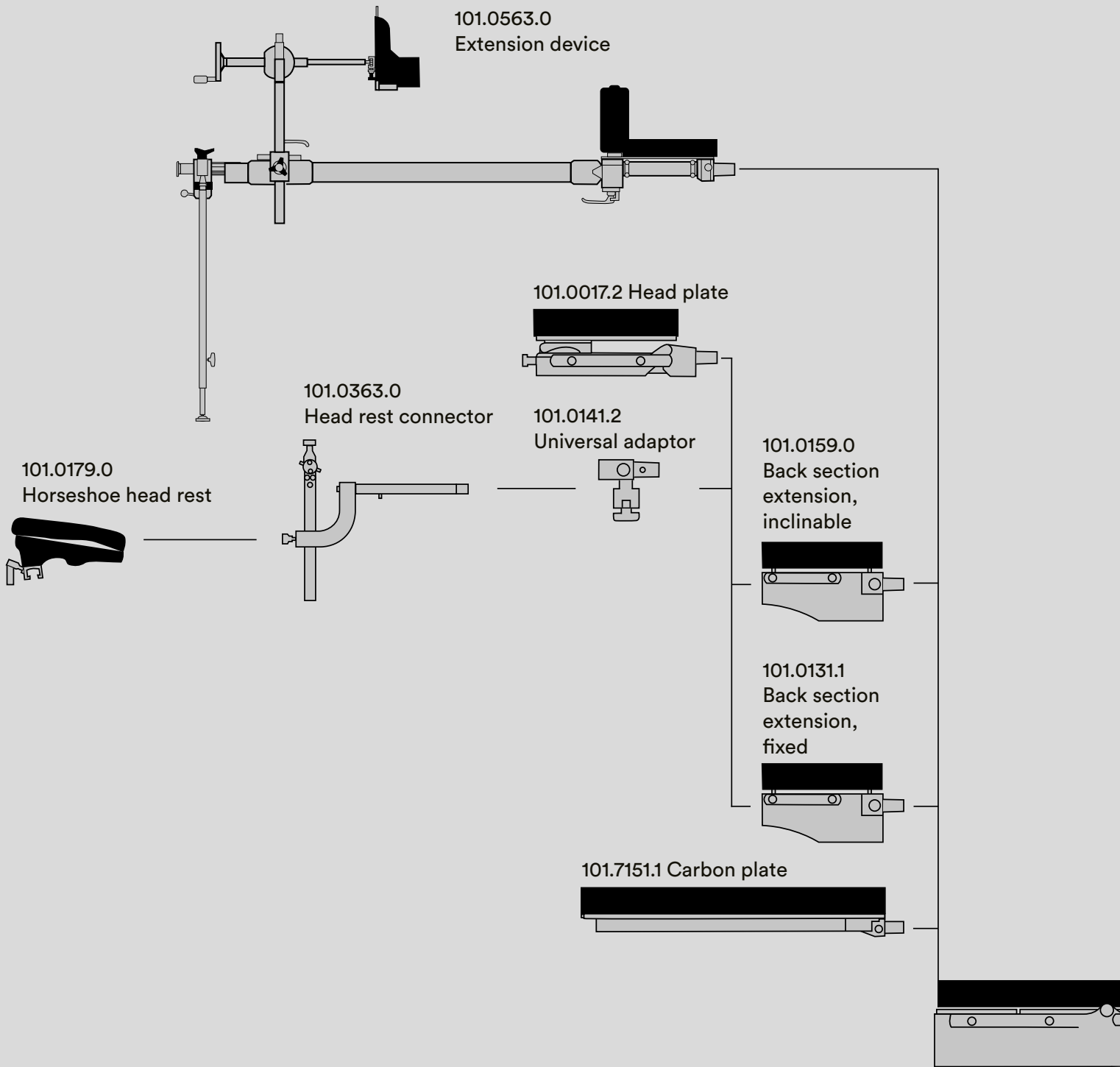

For further accessories, please see our catalogue no. 92.

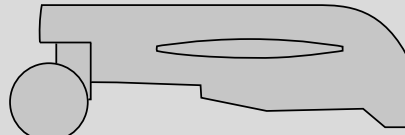

DIAMOND® Selected examples for adaption options

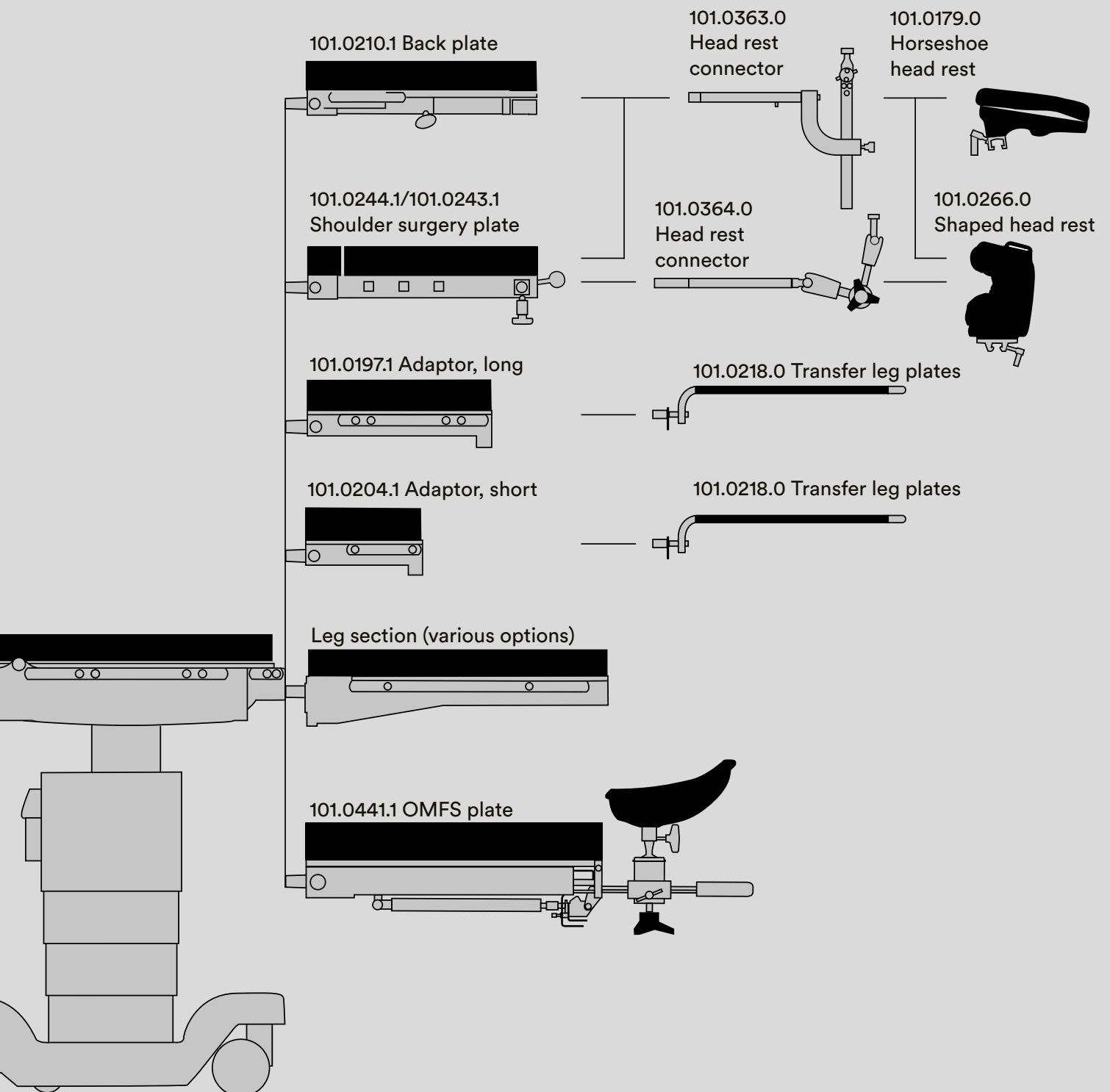

Additional configuration options are described in the operating manual.



Thoracic surgery/kidney position



Gynaecology

For further
positioning examples,
please see
our website!



Shoulder arthroscopy



Extension position – Femur fracture / Hip surgery



DIAMOND® CE^{MD}

Basic models

Model No.	Description
-----------	-------------



170.4001.1 DIAMOND® 40 K

Universal operating table with electrohydraulic adjustment by means of optional hand-held control unit of 4 table functions: **Raise/Lower, Lateral, Trendelenburg/Reverse Trendelenburg, Back section.**

Additional adjustment of these functions by means of optional detachable emergency control (electrohydraulic) model no. 101.0361.0 or emergency handwheels and foot pump (hydraulic). Optionally with or without gyn. cutout. Rechargeable batteries.

Integrated battery charger with mains cable.

Mobile on 4 double castors with central lock, 2 of which antistatic. 1 of the 4 castors with directional lock.

Without head and leg sections, back section extension and hand control unit.



170.4002.1 DIAMOND® 40 LK

similar to DIAMOND® 40 K model, but in addition: **electrohydraulic longitudinal shift function of table-top** by totally 300 mm for optimal use of image intensifier. **Without head and leg sections, back section extension and hand control unit.**

101.0361.0 Emergency control DIAMOND® 40

detachable, cable-connected hand control for all adjustment functions of the table acc. to its hand/foot control, attached to the table column.

DIAMOND® CE^{MD}

Basic models

Model No.	Description
-----------	-------------



170.5500.1 DIAMOND® 50 BK

Universal operating table with electrohydraulic adjustment by means of optional hand-held control unit of 5 table functions: **Raise/Lower, Lateral, Trendelenburg/Reverse Trendelenburg, Back section, Leg section.** Additional adjustment of these functions by means of detachable emergency control (electrohydraulic) or emergency handwheels and foot pump (hydraulic).

With memory function for 8 freely selectable positions and custom 0 position. Optionally with or without gyn. cutout. Rechargeable batteries. Integrated battery charger with mains cable.

Mobile on 4 double castors with central lock, 2 of which antistatic. 1 of the 4 castors with directional lock. **Without head and leg sections, back section extension and hand control unit.**



170.6000.1 DIAMOND® 60 BLK

Similar to DIAMOND® 50 BK, but in addition: **Electro-hydraulic longitudinal shift function of table-top** by totally 300 mm for optimal use of image intensifier. **Without head and leg sections, back section extension and hand control unit.**

Model No.	Description	
101.0227.0 (w/o ill.)	5th directional castor additional spring-loaded fifth directional castor for DIAMOND® models, activated by dual-side foot pedal, not retrofittable. Replaces the castor with directional lock.	
101.0430.0 (w/o ill.)	Double table top for X-ray cassette insertion, for DIAMOND® OR tables with gyn. cutout.	
101.0213.0 (w/o ill.)	80 mm pads for all DIAMOND® models.	Surcharge

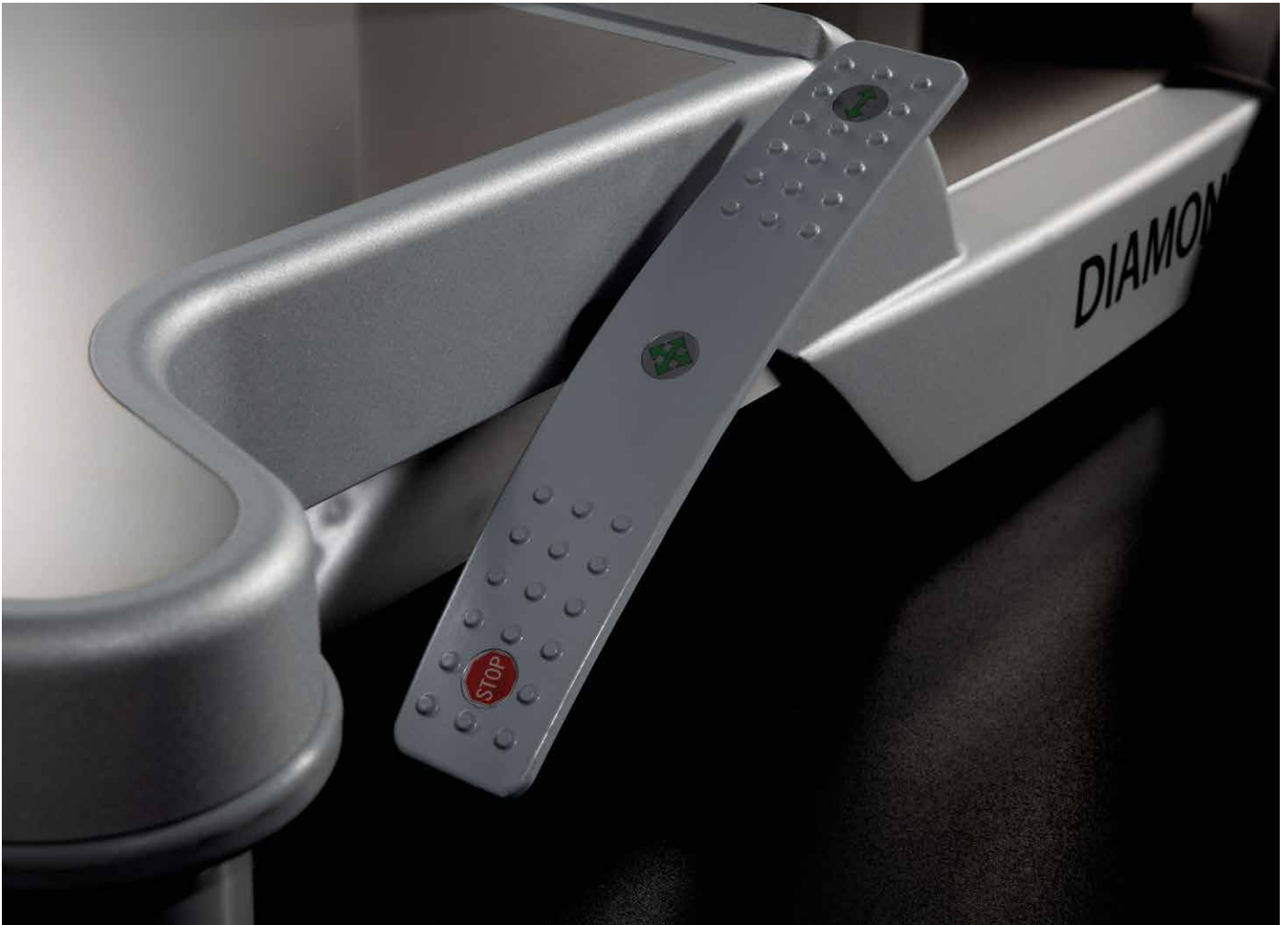

DIAMOND®

Standard configuration

Two-section, radiolucent table-top composed of:

- Back section
- Seat section with cutout for gynaecology (optionally also without gyn. cutout)

Electrohydraulic adjustment functions:

- High/Low
- Trendelenburg/Reverse Trendelenburg
- Lateral tilt
- Back section
- leg sections (DIAMOND® 50 BK and DIAMOND® 60 BLK)
- Longitudinal shift function (DIAMOND® 40 LK and DIAMOND® 60 BLK)

Override systems:

Independent adjustment of table functions by means of detachable emergency control panel (for DIAMOND® 40 models: available as an option), electrohydraulic and emergency control handwheels at the column and foot pump (hydraulic).

Radiolucent table-top, SAF mattress, 60 mm thick, antistatic. Stainless steel table frame construction, sandblasted and electropolished, disinfection-proof. Stainless steel side rails 25 × 10 mm on both sides of the table-top for attachment of accessories, telescopic height adjustment column with stainless steel cover.

Foot cover made of shock-resistant ABS, silver grey, with two stainless steel V4A plates inserted to protect the foot cover, floor pan made of stainless steel V2A. Premium quality stainless steel material 1.4301 is used.

Chassis with 4 double castors, with central lock, 2 of which antistatic. 1 of the 4 castors with directional lock. 5th spring-loaded directional castor, activated by foot pedal on both sides (optional accessory). Replaces the castor with directional lock.

Table with return-to-zero function and crash detection (performance features depending on model). Memory function and individual setting of 0 position (DIAMOND® 50 and 60 models). Input voltage at power supply: 115 V/230 V, 50/60 Hz.

DIAMOND® CE^{MD}

Control elements

Model No. Description



101.0380.1 Hand control unit, cable-connected
plastic casing, sealed against ingress of fluids, cable-connected. Illuminated TFT display indicating all status information of the table. Backlit keyboard for all adjustment functions.
For DIAMOND® 50/60 models.

101.0590.1 Hand control unit, cable-connected
(w/o ill.) similar to 101.0380.1, but for DIAMOND® 40 models, without electrohydraulic leg section adjustment function.



101.0214.1 Hand control unit, Bluetooth®
plastic casing, sealed against ingress of fluids, wireless Bluetooth® connection. Illuminated TFT display indicating all status information of the table. Backlit keyboard for all adjustment functions. Requires Bluetooth® preparation 101.0391.1 and charging cradle 101.0356.0, 101.0357.0 or 101.0358.0!
For DIAMOND® 50/60 models.

101.0591.1 Hand control unit, Bluetooth®
(w/o ill.) similar to 101.0214.1, but for DIAMOND® 40 models, without electrohydraulic leg section adjustment function. Requires Bluetooth® preparation 101.0391.1 and charging cradle 101.0356.0, 101.0357.0 or 101.0358.0!



! Please provide an appropriate charging cradle for your Bluetooth® hand control!

We recommend to always have the table equipped with the Bluetooth® preparation in order to be able to profit from the advantages of the Bluetooth® system even at a later date.

The Bluetooth® control units for DIAMOND® 40 models are only available in conjunction with a cable-connected control unit! Please take this into account when placing your order.



Model No. Description

101.0206.1 Foot control, cable-connected

Cast aluminium casing, sealed against ingress of fluids, antiskid, cable-connected. For all table adjustment functions analogous to its hand-held control. Backlit TFT display for easy navigation, control panel illuminated by LEDs in the foot bar (for MIS). Activation key and “Return to zero” key. Can be connected to the table at the same time as the hand-held control unit. Requires preparation for foot control 101.0397.0. For DIAMOND® 50/60 models.

101.0359.0 Foot control, cable-connected

(w/o ill.) for DIAMOND® 40 models, similar to 101.0206.1, without electrohydraulic leg section adjustment function. Requires preparation for foot control 101.0397.0!

101.0397.0 Preparation for cable-connected foot control

(w/o ill.) Preparation of DIAMOND® operating table for use of a cable-connected foot control unit.



101.0216.1 Foot control, Bluetooth®

similar to 101.0206.1, however with wireless Bluetooth® connection. Incl. power supply unit for recharging the control unit. Requires Bluetooth® preparation 101.0391.1! For DIAMOND® 50/60 models.

101.0360.0 Foot control, Bluetooth®

(w/o ill.) for DIAMOND® 40 models, similar to 101.0216.1, however, without electrohydraulic leg section adjustment function.

101.0391.1 Bluetooth® preparation

(w/o ill.) Preparation of DIAMOND® operating table for use of Bluetooth® hand and foot control unit.



DIAMOND® CE^{MD} Control elements

Model No. Description



101.0356.0 Charging cradle, pedestal version
for DIAMOND® operating tables, pedestal version, charging cradle for inductive charging of Bluetooth® hand control unit, with LED status display, incl. mains adaptor.
You can continue using the hand control while it is charging in the charging cradle.



101.0357.0 Charging cradle, wall mount
same as charging cradle 101.0356.0, but wall-mounted version.



101.0358.0 Charging cradle, side rail
same as charging cradle 101.0356.0, but version for attaching to side rail.



! Please provide an appropriate charging cradle for your Bluetooth® hand control!

DIAMOND®

Basic equipment

Model No. Description

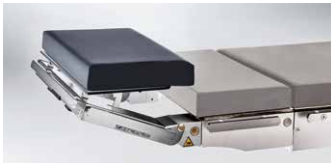

101.0017.2 Head plate
double-adjustment, automatic latching of pad inclination, integrated gas spring for weight compensation, detachable.

101.0480.0 Double table top
(w/o ill.) for X-ray cassette insertion, for head plate 101.0017.2.

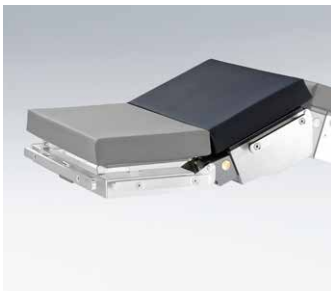

101.0159.0 Back section extension, inclinable
to be attached to the back section, for stretching patient's upper body in thoracic surgery and abdominal interventions, electromotive downward tilt up to 40°, length 300 mm including adapted pad for head section. Requires preparation for electr. adj. accessory 101.0238.0!

101.0238.0 Preparation for electr. adj. accessory
(w/o ill.) Preparation of DIAMOND® operating table for electrically adjustable accessory.

101.0580.0 Double table top
(w/o ill.) for X-ray cassette insertion, for back section extension, inclinable 101.0159.0.



101.0131.1 Back section extension, fixed
to be attached to the back section, length 280 mm.

101.0510.1 Double table top
(w/o ill.) for X-ray cassette insertion, for back section extension, fixed 101.0131.1.

Model No.	Description
-----------	-------------



101.0689.0	Back section extension, short to be attached to the back section, length 200 mm.
-------------------	--

101.0690.0 (w/o ill.)	Double table top for X-ray cassette insertion, for back section extension, short 101.0689.0.
---------------------------------	---

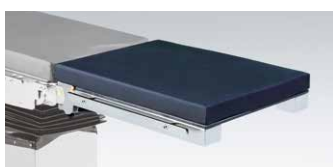

101.0145.2	Leg section one-section type, manual folding with gas spring assistance, detachable.
-------------------	---

101.0490.0 (w/o ill.)	Double table top for X-ray cassette insertion, for leg section 101.0145.2.
---------------------------------	--



101.0621.0	Leg section, light version one-section type, reduced-weight design (7.3 kg), w/o adjustment functions, viscoelastic foam mattress with el. conductive cover, max. weight capacity 40 kg, 700 × 523 mm (L x W).
-------------------	---



101.0116.2	Leg section split type, fold-down, swivelling via latching mechanism, sealed against fluids, integrated gas spring for weight compensation, detachable, with carrying handles. Optionally without gyn. cutout.
-------------------	---

101.0500.0 (w/o ill.)	Double table top for X-ray cassette insertion, for leg sections 101.0116.2.
---------------------------------	---





DIAMOND® CE^{MD}

Universal leg plate

Model No. Description

101.0572.0 Universal leg plate

Four-part leg plate, expands smoothly up to 72° on each side, can also be moved outwards, allows clearance of up to 360 mm for optimised access to operating area. Individually detachable lower leg plates each with separate spreading function up to 45° outwards, folding up to 90°, length adjusts smoothly from 756 mm to a total length of 900 mm. Detachable leg plates with carrying handles.

The four-part leg plate from SCHMITZ at a glance:

- All features of a regular four-part leg plate
- Lower leg segments can be spread and removed and are adjustable in length
- Right and left side can be moved outwards in full length by 180 mm
- Maximum accessibility for the surgeon

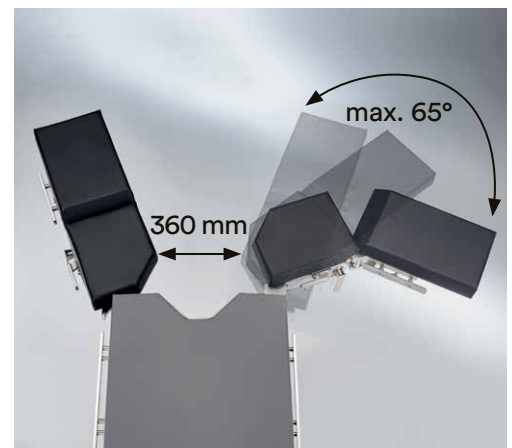
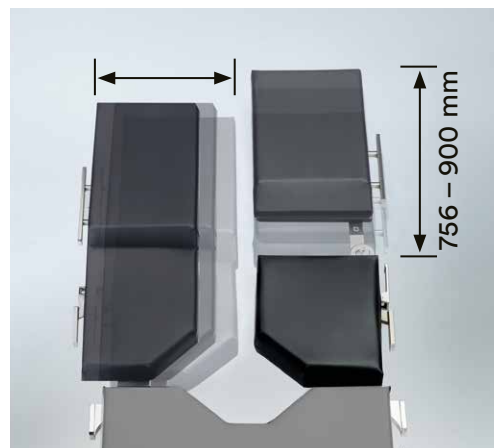



Model No.	Description
-----------	-------------

101.0171.1	Leg section four-part, front part foldable down to 155°, swivelling via latching mechanism, detachable.
-------------------	--

The SCHMITZ leg plate at a glance:

- A closed construction allows easy cleaning, thus meeting the highest demands of hygiene.
- A dual safety system for adjusting the leg plate prevents an accidental folding of the lower segment.
- The folding function can only be carried out after releasing the safety lever and triggering the safety handle.

Optionally without gyn. cutout.

101.0540.0 (w/o ill.)	Double table top for X-ray cassette insertion, for leg plates 101.0171.1.
---------------------------------	---

**For further accessories,
please see our catalogue no. 92.**

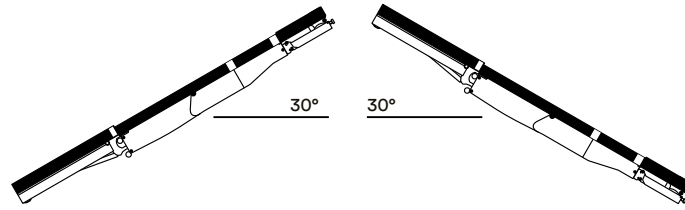

Trendelenburg/Reverse Trendelenburg

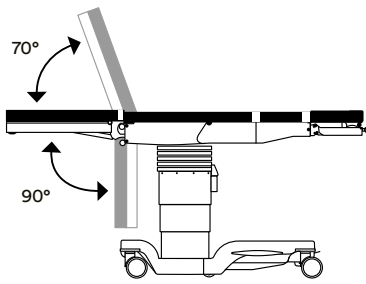

Leg section adjustment

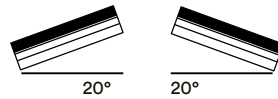

Lateral

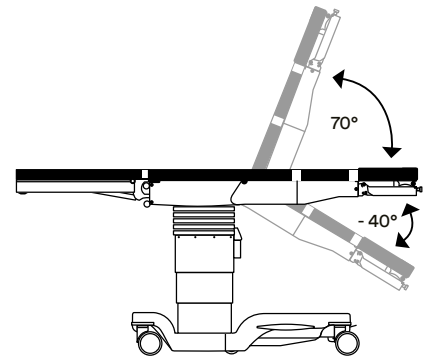

Back section adjustment

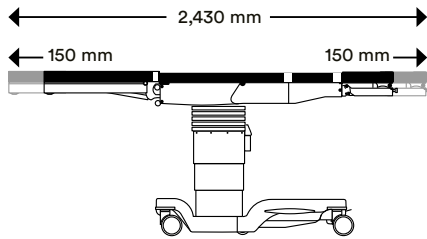

Longitudinal shift
and radiolucent area

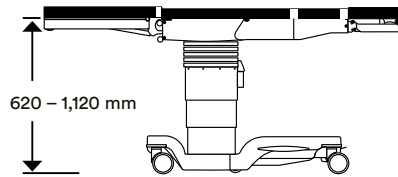

Height adjustment range
(e.g. DIAMOND® 50 BK)

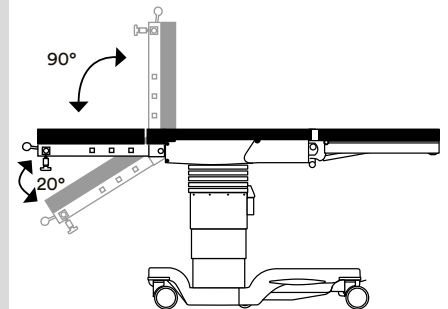

Back section adjustment
with shoulder surgery plate

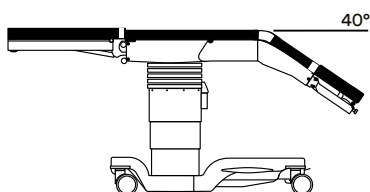

Back section extension,
inclinable

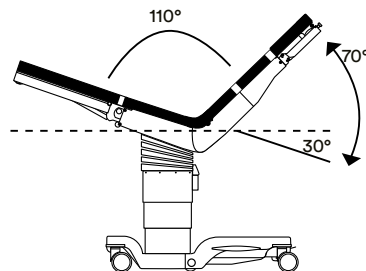

Reflex

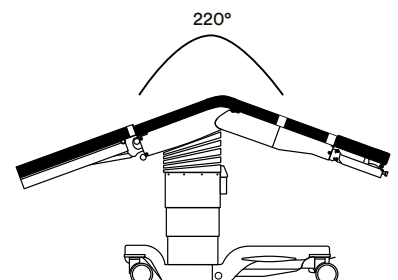

Flex

DIAMOND®

Adjustment functions and dimensions

Length of table-top	960 mm
Length of head section	300 mm
Length of leg section	700 mm
Width of table-top	550 mm
Overall width	610 mm
Table footprint (length x width)	1,140 mm x 705 mm
Diameter of double castors	125 mm
Height adjustment range (w/o pads)	
• DIAMOND® 40 K	615 mm - 1,115 mm
• DIAMOND® 50 BK	620 mm - 1,120 mm
incl. longitudinal shift function	
• DIAMOND® 40 LK	665 mm - 1,165 mm
• DIAMOND® 60 BLK	680 mm - 1,180 mm
Trendelenburg, electrohydraulic	30°
Reverse Trendelenburg, electrohydraulic	30°
Lateral adjustment, electrohydraulic	+/- 20°
Longitudinal shift (DIAMOND® 40 LK and DIAMOND® 60 BLK)	approx. 300 mm
Radiolucent area (DIAMOND® 40 LK / 60 BLK) with longitudinal shift	
• with head & leg sections and back section extension, totally	2,100 mm
• with carbon plate continuous radiolucent area	1,680 mm
Back section, electrohydraulic	- 40°/+ 70°
• with shoulder surgery plate	- 20°/+ 90°
Electrohydraulic inclination of leg section (DIAMOND® 50 BK and 60 BLK)	- 90°/+ 70°
Manual inclination of leg section, gas spring assisted	- 90°/+ 10°
Spread angle of leg plates	120°
Inclination of head section, gas spring assisted	- 45°/+ 25°
Tilt angle of head section pad	25°
Total weight (w/o head and leg sections)	approx. 255 kg
Total weight capacity (static)	up to 454 kg
Safe working load (dynamic)	up to 360 kg
Battery operation	■
Integrated battery charger/mains adaptor	■
Emergency operation via mains power supply	■
Mechanical emergency override of all hydraulic functions	
Voltage range of mains adaptor	115 V/230 V, 50/60 Hz

■ = standard equipment

DIAMOND® **Recommended accessories****General surgery**

Model No.	Description
101.0017.2	Head plate
101.0116.2	Leg section
101.0192.0	Arm rest
101.0123.0	Wristlet
101.0177.1	Body restraint strap
101.0012.0	Anaesthetic frame
101.0111.0	Anaesthetic frame extension

**Minimally invasive surgery/
Laparoscopy**

Model No.	Description
-----------	-------------

**DIAMOND® 60 BLK
with gyn. cutout**

101.0017.2	Head plate
101.0116.2	Leg section

as an alternative to 101.0116.2

101.0572.0	Universal leg plate
------------	---------------------

alternatively

101.0218.0	Transfer leg plates
------------	---------------------

optionally

101.0019.0	Arm rest
101.0123.0	Wristlet
101.0164.0	2 x Leg restraint strap
101.0012.0	Anaesthetic frame
101.0111.0	Anaesthetic frame extension
101.0115.0	2 x Göpel-type leg support
101.0146.0	2 x Clamp

Urology/TUR

Model No.	Description
-----------	-------------

**DIAMOND® 60 BLK/40 LK
with gyn. cutout**

101.0017.2	Head plate
101.0116.2	Leg section

alternatively

101.0218.0	Transfer leg plates
101.0204.1	Adaptor, short
101.0362.0	Rinsing basin with outlet
101.0191.0	TUR sieve
101.0115.0	2 x Göpel-type leg support
101.0146.0	2 x Clamp
101.0129.0	Elbow rests (pair)

alternatively for TUR

101.0197.1	Adaptor, long
101.0584.1	Gyro flushing basin
101.0588.0	TUR sieve
101.0019.0	Arm rest
101.0123.0	Wristlet
101.0012.0	Anaesthetic frame
101.0111.0	Anaesthetic frame extension

Gynaecology

Model No.	Description
-----------	-------------

**DIAMOND® 60 BLK
with gyn. cutout**

101.0017.2	Head plate
101.0116.2	Leg section w/o gyn. cutout

alternatively

101.0218.0	Transfer leg plates
101.0115.0	2 x Göpel-type leg support
101.0146.0	2 x Clamp

alternatively

101.0369.0	UniLeg leg supports (pair) with peroneal nerve protection
------------	---

alternatively

101.0678.0	UniLeg leg supports (pair)
101.0019.0	Arm rest
101.0123.0	Wristlet
101.0012.0	Anaesthetic frame
101.0111.0	Anaesthetic frame extension

ENT/OMFS

Model No.	Description
-----------	-------------

**DIAMOND® 50 BK or 60 BLK
OR table model w/o gyn. cutout****Variant 1**

101.0017.2	Head plate
101.0332.0	Gel head ring
101.0116.2	Leg section

**Variant 2 - Reverse patient position
instead of the leg section**

101.0441.1	OMFS plate
------------	------------

alternatively

101.0141.2	Universal adaptor
101.0179.0	Horseshoe head rest
101.0364.0	Head rest connector
101.0116.2	Leg section

additionally, for all variants

101.0019.0	2 x Arm rest
101.0177.1	Body restraint strap

optionally: foot control

DIAMOND® CE^{MD}**Recommended accessories****Ophthalmology**

Model No.	Description
-----------	-------------

**Reverse patient position
DIAMOND® 50 BK or 60 BLK
w/o gyn. cutout**

Variant 1

101.0131.1	Back section extension
101.0116.2	Leg section
101.0019.0	Arm rest
101.0141.2	Universal adaptor
101.0256.0	Horseshoe head rest with one-hand operation

Variant 2

101.0441.1	OMFS plate
101.0019.0	2 x Arm rest

optionally: foot control**Variant 3**

101.0210.1	Back plate
101.0256.0	Horseshoe head rest with one-hand operation

or

101.0364.0	Head rest connector
101.0179.0	Horseshoe head rest

Rectum surgery

Model No.	Description
-----------	-------------

OR table model with gyn. cutout**Variant 1 in lithotomy position**

101.0017.2	Head plate
101.0115.0	2 x Göpel-type leg support
101.0146.0	2 x Clamp
101.0019.0	2 x Arm rest
101.0010.0	Shoulder support (pair)

**as an alternative to
101.0115.0/101.0146.0**

101.0572.0	Universal leg plate
------------	---------------------

**as an alternative to
101.0115.0/101.0146.0**

101.0369.0	UniLeg leg supports (pair) with peroneal nerve protection
------------	---

or

101.0678.0	UniLeg leg supports (pair)
------------	-------------------------------

Variant 2 in prone position

101.0017.2	Head plate
101.0116.2	Leg section with gyn. cutout
101.0019.0	2 x Arm rest
101.0186.1	Knee/foot rest
101.0190.0	2 x Lateral support pad
101.0178.0	Rectoscopy/Buttocks support
101.0146.0	2 x Clamp
101.0012.0	Anaesthetic frame
101.0111.0	Anaesthetic frame extension

**Kidney surgery/
Thoracic surgery**

Model No.	Description
-----------	-------------

**DIAMOND® 50 BK or 60 BLK
with gyn. cutout**

101.0017.2	Head plate
101.0116.2	Leg section w/o gyn. cutout

alternatively

101.0159.0	Back section extension, inclinable
101.0352.0	Gel lateral leg positioner
101.0121.0	3 x Support
101.0162.0	2 x Back/Buttock support
101.0175.0	Pubis support
101.0192.0	2 x Arm rest
101.0177.1	Body restraint strap
101.0012.0	Anaesthetic frame
101.0111.0	Anaesthetic frame extension

Bariatric surgery

Model No.	Description
-----------	-------------

OR table model with gyn. cutout

101.0017.2	Head plate
101.0116.2	Leg section with gyn. cutout

alternatively

101.0572.0	Universal leg plate
101.0194.0	Set of extension pads 500 mm long (set of 2)
101.0200.0	Set of extension pads 300 mm long (set of 2)
101.0019.0	2 x Arm rest
101.0455.1	Body restraint strap
101.0368.0	Foot plate (pair)
101.0010.0	Shoulder support (pair)
101.0185.0	Leg restraint strap

**as an alternative to the variants
using leg sections:**

101.0219.0	Göpel-type leg support heavy-duty (pair)
101.0147.0	2 x Clamp
101.0012.0	Anaesthetic frame
101.0111.0	Anaesthetic frame extension

DIAMOND® CE^{MD}**Recommended accessories****Spinal surgery**

Model No.	Description
DIAMOND® 60 BLK/40 LK w/o gyn. cutout	
101.0017.2	Head plate
101.0116.2	Leg section
101.0131.1	Back section extension, fixed

alternatively

101.7151.1	Carbon plate
101.7152.0	2 x Side rail for carbon plate

optionally

101.0355.0	Gel large prone positioner
101.0019.0	2 x Arm rest
101.0012.0	Anaesthetic frame

in knee-elbow position

101.0682.0	Knee/foot plates (pair)
101.0190.0	2 x Lateral support pad
101.0178.0	Rectoscopy/buttocks support
101.0146.0	2 x Clamp

Vascular surgery

Model No.	Description
DIAMOND® 60 BLK w/o gyn. cutout	
101.0017.2	Head plate
101.0116.2	Leg section
101.0131.1	Back section extension, fixed
101.0019.0	2 x Arm rest

as an alternative to 101.0116.2

101.7151.1	Carbon plate
101.7152.0	Side rail for carbon plate

Neurosurgery

Model No.	Description
-----------	-------------

**DIAMOND® 50 BK or 60 BLK
w/o gyn. cutout**

101.0017.2	Head plate
101.0116.2	Leg section w/o gyn. cutout

in supine/prone position

101.0131.1	Back section extension
101.0141.2	Universal adaptor
101.0113.0	DORO Skull Clamp adaptor
101.0142.0	DORO Universal basic unit
101.0127.0	DORO Skull Clamp

**in semi-seated position /
beach chair position**

101.0014.0	Cross-bar attachment
101.0018.0	2 x Clamp
101.0113.0	DORO Skull Clamp adaptor
101.0142.0	DORO Universal basic unit
101.0127.0	DORO Skull Clamp
101.0019.0	2 x Arm rest

alternatively

Accessories for head positioning
in radiolucent material

**Upper limb
trauma surgery**

Model No.	Description
-----------	-------------

**OR table model
w/o gyn. cutout**

101.0017.2	Head plate
101.0116.2	Leg section
101.0136.0	Humerus positioning device
101.0146.0	Clamp
101.0152.0	Humerus countertraction post
101.0146.0	Clamp
101.0163.1	Weinberger hand traction device
101.0122.0	Upper arm positioning device
101.0117.0	Clamp
101.0257.0	Axilla support
101.0258.0	Elbow support
101.0105.0	Traction unit
101.0123.0	Wristlet
101.0177.1	Body restraint strap

DIAMOND® CE^{MD}**Recommended accessories****Lower limb
trauma surgery**

Model No.	Description	Model No.	Description
OR table model w/o gyn. cutout		101.0019.0	Arm rest
101.0017.2	Head plate	101.0012.0	Anaesthetic frame
101.0563.0	Extension device, carbon with standard accessories: 1 x seat section, carbon fibre, with upholstery 2 x extension bars, carbon fibre 2 x extension bar supports, SST 2 x extension shoes for adults 1 x countertraction rod for supine position	101.0137.0	Wristlet
101.0566.0	Transport trolley	add. for treatment of femur/neck of femur	
101.0594.0	Countertraction post for lateral position	101.0115.0	Göpel-type leg support
101.0567.0	Transfer leg plates (pair)	101.0146.0	Clamp
		101.0596.0	Side rail extension
		add. for treatment of tibial fracture	
		101.0568.0	Traction device for tibial fractures
		101.0676.0	Kirschner wire device
		101.0569.0	Condyle fixation
		101.0115.0	Göpel-type leg support
		101.0146.0	Clamp
		101.0596.0	Side rail extension
		add. for hip arthroscopy	
		101.0320.0	Pad for hip arthroscopy

Shoulder arthroscopy

Model No.	Description
DIAMOND® 50 BK or 60 BLK beach chair position	
101.0244.1	Shoulder surgery plate
101.0116.2	Leg section
101.0266.0	Shaped head rest for shoulder surgery
101.0364.0	Head rest connector
101.0192.0	2 x Arm rest
101.0177.1	Body restraint strap

Knee arthroscopy

Model No.	Description
101.0017.2	Head plate
101.0171.1	Leg section
101.0019.0	Arm rest
101.0012.0	Anaesthetic frame
101.0137.0	Wristlet
101.0212.0	Knee positioning device
101.0146.0	Clamp

alternatively

101.0583.0	Knee arthroscopy support
------------	-----------------------------



Contact

SCHMITZ u. Söhne
GmbH & Co. KG
Zum Ostenfeld 29
58739 Wickede (Ruhr)

P. O. Box 14 61
58734 Wickede (Ruhr)
Germany

T +49 (0)2377 84 0
F +49 (0)2377 84 162
zentrale@schmitz-soehne.de

Exports department:
T +49 (0)2377 84 0
F +49 (0)2377 84 135
export@schmitz-soehne.de

Technical service, hotline:
T +49 (0)2377 84 549
F +49 (0)2377 84 210
service@schmitz-soehne.de

Information on our
establishments worldwide
can be found
on our website:

www.schmitz-soehne.com



All devices marked with the CE-MD symbol, in combination with our accessories, meet the requirements of Medical Device Regulation 2017/745/EU (MDR) as well as the Medical Device Amendment Act and are risk class I medical devices.



All devices marked with the simple CE symbol meet the requirements of low-voltage directive 2014/35/EU as well as the regulation on electrical equipment.

Please also refer to the instructions for use, for more details about the intended use!



* This product is an article of merchandise, sold under OEM brand name.

Our goods and services are to be understood ex works. Deliveries are effected via our authorized partners or branch offices. The company reserves the right to alter the design, construction, dimensions and finish of its products without notice. All relevant dimensions and weights are to be understood as approximate information/ data. Due to technical reasons colour deviations are possible. The patient positionings shown in this catalogue are only exemplary and make no claim to the correctness and/or completeness of the accessories, please observe the instructions for use in any case.

The articles shown in this catalogue are not authorized for sale in the United States.

Nominal charge 3.00 Euro.